



Commercial + Industrial
WATER TREATMENT SOLUTIONS



“The CTF System has exceeded my expectations.”

— Paul Bretones, Manager of Engineering for Shell Point Retirement Community

“We are amazed at how clean our systems have become.”

— Steve Cronin, Finishing Engineer for Henniges Automotive

“This test clearly proves the EasyWater No-Salt Conditioner lives up to its claims in a real-world situation.”

— Bryan Schoening, Facility Maintenance Director for Core Civic / Nevada Southern Detention Center

OUR SOLUTIONS

2

CTF System

COOLING TOWER TREATMENT SYSTEM

14

SimplySoft

LONG-LASTING WATER SOFTENER

4

Series C System

CLOSED LOOP TREATMENT SYSTEM

15

PoolShield

LOW-CHEMICAL TREATMENT FOR POOLS & SPAS

6

DWP System

DOMESTIC WATER PROTECTION SYSTEM

16

IronShield

EFFECTIVE WELL WATER FILTRATION SYSTEM

8

SmartGuard RO

INTELLIGENT REVERSE OSMOSIS SYSTEM

16

ToxinShield

REMOVES DANGEROUS CONTAMINANTS

10

SedimentShield

SUB-MICRON FILTRATION SYSTEM

17

LeadShield

REMOVES LEAD AND OTHER HEAVY METALS

12

No-Salt Conditioner

PREVENTS & REMOVES SCALE AND BIOFILM

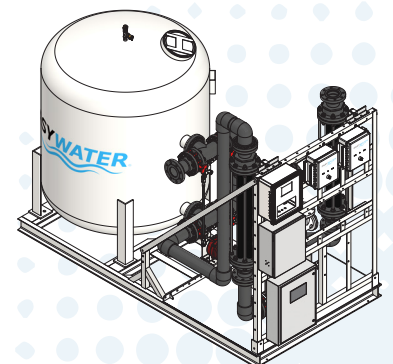

CTF System

COOLING TOWER TREATMENT SYSTEM

An innovative way to reduce scale, corrosion, bacteria and Legionella risk in cooling towers

The 3 Major Problems in Cooling Tower Systems:

- 1 Limescale deposits in condenser tubes, piping and cooling tower fill
- 2 High corrosion rates
- 3 High bacteria counts, biofilm and the presence of Legionella

How CTF Solves the 3 Major Problems in Cooling Tower Systems:

SEDIMENTSHIELD SUB-MICRON FILTRATION

- ▶ Utilizes EasyWater's sub-micron SedimentShield media, which is a proprietary blend of media that backwashes clean and does not harbor bacteria
- ▶ SedimentShield media has an expected life of 20+ years
- ▶ Removes over 99% of bacteria in the water
- ▶ Significantly reduces turbidity or cloudiness in the water, which increases the effectiveness of the UV system
- ▶ Sub-micron filtration results in cleaner sump basins (particles are not heavy enough to settle) and reduced Legionella risk
- ▶ Removal of bacteria through sub-micron filtration and UV, results in extremely low bacteria counts, minimal biocide and less corrosion

ULTRAVIOLET (UV) SYSTEM

- ▶ Kills bacteria on contact
- ▶ Minimizes the use of biocides, which lowers corrosion rates and saves money
- ▶ UV provides highly effective sanitization and is protected from deposits and performance loss by the SedimentShield filtration and No-Salt Conditioner

NO-SALT CONDITIONERS

- ▶ Dramatically reduces or eliminates anti-scalant chemicals
- ▶ Helps remove scale and biofilm in the system, as well as in the UV, which helps maintain the rated effectiveness of the UV
- ▶ Minimizes system biofilm, which reduces Legionella risk
- ▶ Breaks down the cell wall of bacteria
- ▶ Causes flocculation of particles in the water, increasing filtration effectiveness
- ▶ Removes insulating limescale and biofilm from chiller condenser tubes, which saves 5% to 45%+ energy

“In less than 3 weeks of CTF treatment, the bacteria levels went from 10^5 to 10^0 , and Legionella from 1,790 to None.”

— Boca Raton Regional Hospital



Legionella Test Results		
BEFORE	4/30/19	1,110 CFU/mL
BEFORE	5/10/19	1,790 CFU/mL
AFTER	6/24/19	NONE

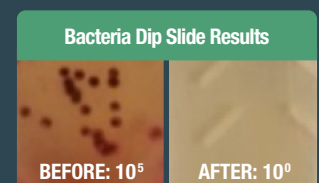

Manufacturing Options & Sizing

SKID-MOUNTED

Pre-plumbed and pre-wired on a steel skid

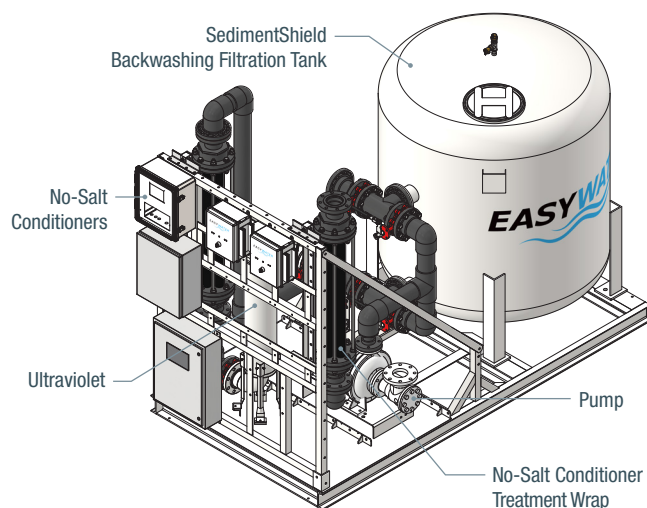

INDIVIDUAL COMPONENTS

Individual components are plumbed and wired on site

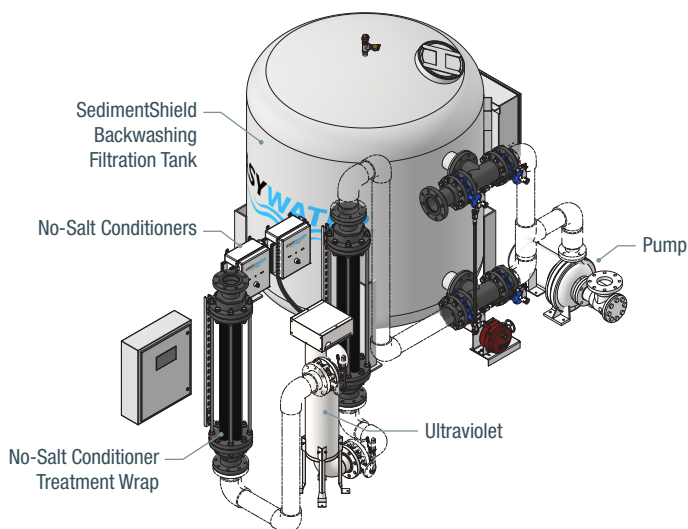

Model #	Cooling Tower Tons ¹	Cooling Tower GPM ²	Steel Tank Dim	Sidestream GPM
CTF-12-S	80	240	12" x 60"	12
CTF-25-S	167	500	18" x 60"	25
CTF-50-S	333	1,000	24" x 60"	50
CTF-75-S	500	1,500	30" x 65"	75
CTF-100-S	667	2,000	36" x 65"	100
CTF-150-S	1,000	3,000	42" x 65"	150
CTF-185-S	1,233	3,700	48" x 72"	185
CTF-235-S	1,567	4,700	54" x 72"	235
CTF-300-S	2,000	6,000	60" x 72"	300
CTF-360-S	2,400	7,200	66" x 72"	360
CTF-425-S	2,833	8,500	72" x 72"	425
CTF-500-S	3,333	10,000	78" x 72"	500
CTF-580-S	3,867	11,600	84" x 72"	580

Model selection can vary based on water quality and system volume.

Options such as stainless tanks, piping and skids along with dual pumps and various control options are available upon request. Contact EasyWater or local rep for more information.

¹Total cooling tower tons based on peak load. ²Total cooling tower GPM based on 3gpm/ton.

Model #	Cooling Tower Tons ¹	Cooling Tower GPM ²	Filtration Tanks	Sidestream GPM
CTF-12	80	240	12" x 54" FRP	12
CTF-20	133	400	16" x 65" FRP	20
CTF-35	233	700	21" x 62" FRP	35
CTF-50	333	1,000	24" x 72" FRP	50
CTF-75	500	1,500	30" x 72" FRP	75
CTF-75	500	1,500	30" x 65" Steel	75
CTF-100	667	2,000	36" x 72" FRP	100
CTF-100	667	2,000	36" x 65" Steel	100
CTF-150	1,000	3,000	42" x 72" FRP	150
CTF-150	1,000	3,000	42" x 65" Steel	150
CTF-185	1,233	3,700	48" x 72" Steel	185
CTF-200	1,333	4,000	2 - 36" x 72" FRP	200
CTF-235	1,567	4,700	54" x 72" Steel	235
CTF-300	2,000	6,000	60" x 72" Steel	300
CTF-300	2,000	6,000	2 - 42" x 72" FRP	300
CTF-350	2,333	7,000	66" x 72" Steel	350
CTF-425	2,833	8,500	72" x 72" Steel	425
CTF-450	3,000	9,000	3 - 42" x 72" FRP	450
CTF-500	3,333	10,000	78" x 72" Steel	500
CTF-580	3,867	11,600	84" x 72" Steel	580
CTF-600	4,000	12,000	4 - 42" x 72" FRP	600

Model selection can vary based on water quality and system volume.

Options such as stainless tanks along with dual pumps and various control options are available upon request. Contact EasyWater or local rep for more information.

¹Total cooling tower tons based on peak load. ²Total cooling tower GPM based on 3gpm/ton.

Series C

CLOSED LOOP TREATMENT SYSTEM

An effective and chemical-free solution for treating closed loops

The 3 Major Problems in Closed Loops:

- 1 Corrosion caused by dissolved oxygen
- 2 Sediment and sub-micron metal particles in the water
- 3 Insulating high iron content, limescale and biofilm deposits

How Series C Solves the 3 Major Problems in Closed Loops:

DISSOLVED OXYGEN REMOVAL MEDIA

- ▶ Continually removes dissolved oxygen from the closed loop, resulting in extremely low corrosion levels
- ▶ Eliminates the need for chemical in all closed loops
- ▶ Greatly outperforms chemical treatment
- ▶ Eliminates the bacterial food source caused by chemical
- ▶ Minimizes the threat of aerobic bacteria growth, which requires oxygen to live
- ▶ Eliminates the need for pH adjusting chemicals

NO-SALT CONDITIONER

- ▶ Helps remove existing deposits while keeping new deposits from forming
- ▶ Breaks down the cell wall of bacteria
- ▶ Causes flocculation of particles, increasing filtration effectiveness

SEDIMENTSHIELD FILTRATION MEDIA

- ▶ Filtering to sub-micron levels is highly effective, as filtration tests show that the very fine metal or magnetite particles in most closed loops are below 1 micron in size
- ▶ Sub-micron filtration helps filter bacteria from the closed loop water and backwash it to drain
- ▶ Removing sediment to such fine levels helps minimize erosion of pump seals and impellers
- ▶ Self-backwashing sub-micron media provides superior closed loop filtration with minimal ongoing maintenance
- ▶ System backwashes with city water in lieu of closed loop water to keep the system closed

“ I'm very impressed with the very low iron and copper levels. This indicates great corrosion control in the system. ”

— Consultant for Tallahassee Community College



Results After Series C Treatment	
Copper	0 PPM
Iron	0 PPM
Dissolved Oxygen	< 1 PPM

Manufacturing Options & Sizing

SKID-MOUNTED

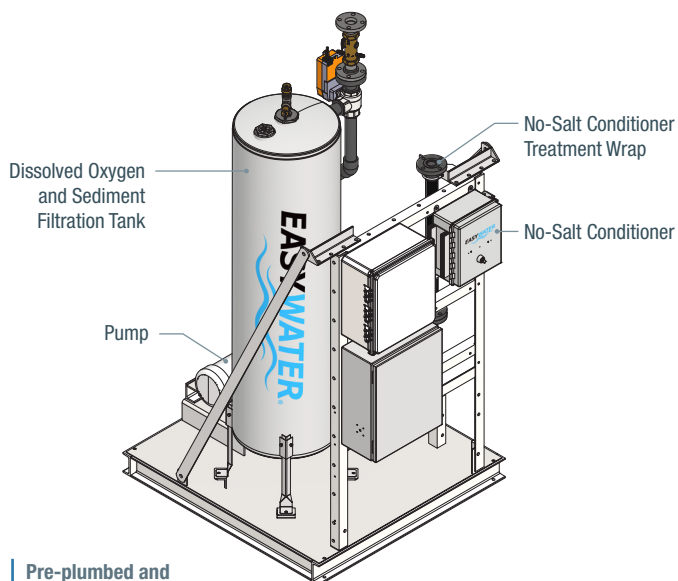

Pre-plumbed and pre-wired on a steel skid

Model # ¹	Max System Gals ²	Steel Tank Dim ³	Sidestream GPM
CLC/CLH-1000-S	4,000	12" x 60"	12
CLC/CLH-2000-S	10,000	18" x 60"	25
CLC/CLH-3000-S	25,000	24" x 60"	50
CLC/CLH-4000-S	45,000	30" x 65"	75
CLC/CLH-5000-S	70,000	36" x 65"	100
CLC/CLH-6000-S	120,000	42" x 65"	150
CLC/CLH-7000-S	150,000	48" x 72"	185
CLC/CLH-8000-S	200,000	54" x 72"	235
CLC/CLH-9000-S	300,000	60" x 72"	300
CLC/CLH-10000-S	375,000	66" x 72"	360
CLC/CLH-11000-S	440,000	72" x 72"	425
CLC/CLH-12000-S	500,000	78" x 72"	500
CLC/CLH-13000-S	600,000	84" x 72"	580

Options such as stainless tanks, piping and skids along with dual pumps and various control options are available upon request. Contact EasyWater or local rep for more information.

¹ Use "CLC" for chilled water applications and "CLH" for hot water applications

² Total volume of water in the closed loop

³ Steel tank contains dissolved oxygen removal media and sub-micron SedimentShield media

INDIVIDUAL COMPONENTS

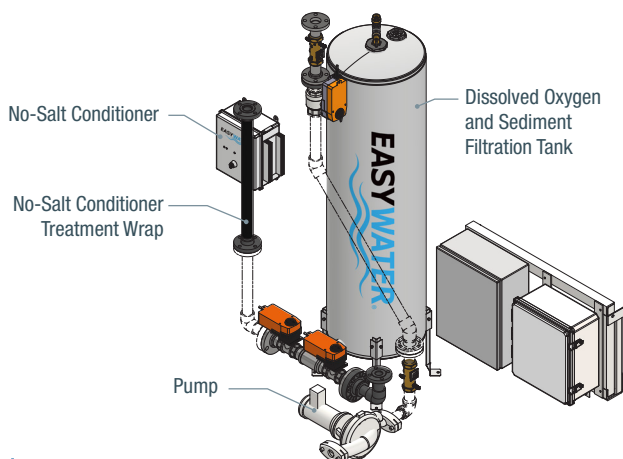

Individual components are plumbed and wired on site

Model # ¹	Max System Gals ²	Steel Tank Dim ³	Sidestream GPM
CLC/CLH-1000	4,000	12" x 60"	12
CLC/CLH-2000	10,000	18" x 60"	25
CLC/CLH-3000	25,000	24" x 60"	50
CLC/CLH-4000	45,000	30" x 65"	75
CLC/CLH-5000	70,000	36" x 65"	100
CLC/CLH-6000	120,000	42" x 65"	150
CLC/CLH-7000	150,000	48" x 72"	185
CLC/CLH-8000	200,000	54" x 72"	235
CLC/CLH-9000	300,000	60" x 72"	300
CLC/CLH-10000	375,000	66" x 72"	360
CLC/CLH-11000	440,000	72" x 72"	425
CLC/CLH-12000	500,000	78" x 72"	500
CLC/CLH-13000	600,000	84" x 72"	580

Options such as stainless tanks and piping along with dual pumps and various control options are available upon request. Contact EasyWater or local rep for more information.

¹ Use "CLC" for chilled water applications and "CLH" for hot water applications

² Total volume of water in the closed loop

³ Steel tank contains dissolved oxygen removal media and sub-micron SedimentShield media

DWP System

DOMESTIC WATER PROTECTION SYSTEM

A chemical-free solution to reduce Legionella risk in domestic water systems

The 2 Key Factors for Protecting Domestic Water Systems from Legionella Problems:

- 1 Eliminate incoming bacteria, nutrients and Legionella
- 2 Remove existing biofilm and scale deposits so it has no place to live and multiply

DWP SYSTEM COMPONENTS:

SEDIMENTSHIELD SUB-MICRON FILTRATION

- ▶ Utilizes EasyWater's sub-micron SedimentShield media, which is a proprietary blend of media that backwashes clean and does not harbor bacteria
- ▶ SedimentShield media has an expected life of 20+ years
- ▶ Removes over 99% of sediment, unwanted nutrients, and bacteria from the water, which significantly reduces the threat of Legionella in domestic water systems
- ▶ Reduces turbidity or cloudiness in the water, which increases the effectiveness of the UV system

NO-SALT CONDITIONER

- ▶ Minimizes Legionella risk throughout the domestic water system by eliminating scale buildup and reducing or eliminating system biofilm
- ▶ Reduces or eliminates existing biofilm in both hot and cold domestic water systems
- ▶ Helps maintain the rated effectiveness of the UV by preventing scale and biofilm on the UV lamps
- ▶ Prevents and removes scale buildup in the domestic water system, helping water-using equipment last longer and work more efficiently

ULTRAVIOLET (UV) SYSTEM

- ▶ Kills bacteria on contact
- ▶ UV provides highly effective sanitization and is protected from deposits and performance loss by the SedimentShield filtration and No-Salt Conditioner



ACCORDING TO THE CDC:

A variety of internal and external factors can lead to Legionella problems in your building, including:

- BIOFILM → SCALE AND SEDIMENT → CHANGES IN MUNICIPAL WATER QUALITY

Source: Legionella Growth and Spread. (April 30, 2018). CDC. <https://cdc.gov/legionella/wmp/overview/growth-and-spread.html>

Manufacturing Options & Sizing

SKID-MOUNTED

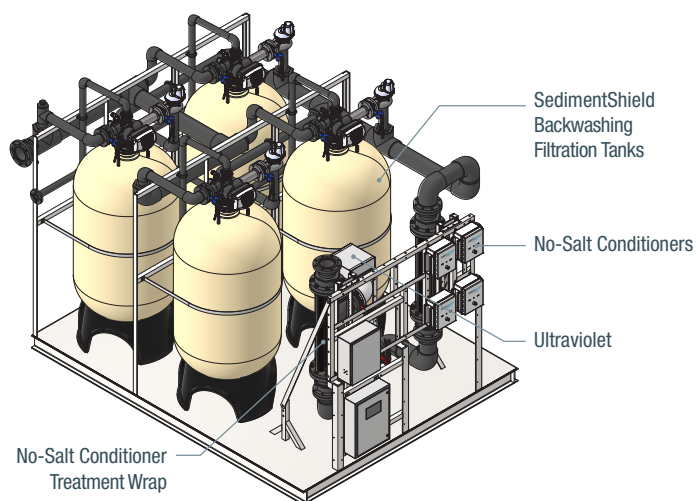

Pre-plumbed and pre-wired on a steel skid

Model #	Max GPM ¹	Main Size	FRP Tank Dim
DWP-15-S	15	1"	18" x 65"
DWP-30-S	30	1-1/4"	24" x 72"
DWP-50-S	50	1-1/2" or 2"	30" x 72"
DWP-100-S	100	2-1/2" or 3"	42" x 72"
DWP-200-S	200	4"	2 - 42" x 72"
DWP-300-S	300	4" or 6"	3 - 42" x 72"
DWP-400-S	400	6"	4 - 42" x 72"
DWP-500-S	500	6" or 8"	5 - 42" x 72"
DWP-600-S	600	8"	6 - 42" x 72"

¹ DWP Systems are sized based on the estimated max gpm in a domestic water system

INDIVIDUAL COMPONENTS

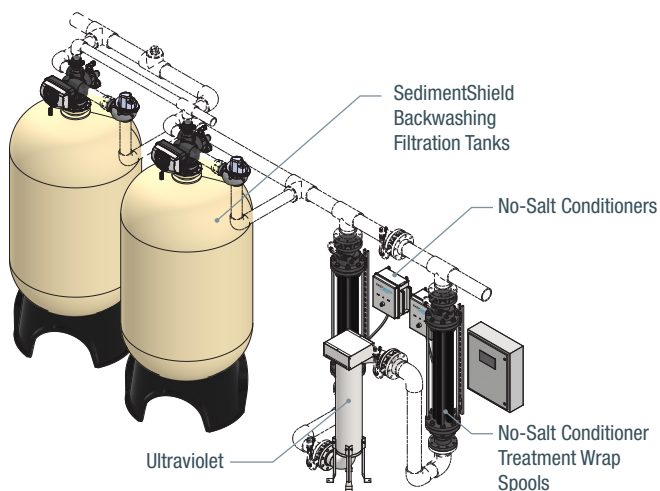

Individual components are plumbed and wired on site

Model #	Max GPM ¹	Main Size	FRP Tank Dim
DWP-15	15	1"	18" x 65"
DWP-30	30	1-1/4"	24" x 72"
DWP-50	50	1-1/2" or 2"	30" x 72"
DWP-100	100	2-1/2" or 3"	42" x 72"
DWP-200	200	4"	2 - 42" x 72"
DWP-300	300	4" or 6"	3 - 42" x 72"
DWP-400	400	6"	4 - 42" x 72"
DWP-500	500	6" or 8"	5 - 42" x 72"
DWP-600	600	8"	6 - 42" x 72"
DWP-700	700	8"	7 - 42" x 72"
DWP-800	800	8" or 10"	8 - 42" x 72"
DWP-900	900	10"	9 - 42" x 72"
DWP-1000	1,000	10"	10 - 42" x 72"

¹ DWP Systems are sized based on the estimated max gpm in a domestic water system



SmartGuard™

REVERSE OSMOSIS

An intelligent and dependable RO system that doesn't require softener or chemical pretreatment

SmartGuard RO is an intelligent water filtration system built to work hard and think hard. You'll get the water quality you need without the downtime and maintenance headaches associated with typical reverse osmosis systems.

SmartGuard Features & Benefits:

MICROPROCESSOR DRIVEN WITH TOUCH SCREEN



- ▶ SmartGuard combines a powerful on-board microprocessor with digital sensors and custom firmware
- ▶ Measures and reports performance data, operation alarms and maintenance needs
- ▶ Touch screen display keeps you informed of system and filter condition and provides an on-board interface for making adjustments
- ▶ Dry contacts provide remote monitoring and remote control capability for building automation systems (BACnet option available)

AUTOMATIC BYPASS

- ▶ Senses low tank volume and automatically bypasses itself
- ▶ Partially filtered or raw water is automatically delivered as needed while SmartGuard works to re-fill your tank

CUSTOMIZED WATER PROFILE

- ▶ Customizable for ultra high purity applications using mixed-bed DI, electrodeionization, UV, sub-micron filtration, etc
- ▶ Automatic TDS blending adjusts to provide consistent water quality according to your desired outlet TDS set point
- ▶ Dual output of different TDS water profiles available for applications requiring both pure RO water and partially remineralized RO water
- ▶ Both the raw RO permeate and blended/remineralized RO outlet quality are digitally measured and alarmed if outside of range

PROGRAMMABLE DRAIN/RECOVERY RATIO

- ▶ SmartGuard automatically adjusts system components to maintain performance amidst changing feed water and filter conditions
- ▶ Calculates recovery rate and varies drain flow to maintain targeted efficiency ratio
- ▶ Provides consistent performance while maximizing energy, water and filter use

INTEGRATED WATER CONDITIONING AND CLEANING

- ▶ SmartGuard eliminates the associated cost, regulation, and pollution from the use of chemicals and salt
- ▶ EasyWater's proprietary No-Salt Conditioner treatment is integrated in to the SmartGuard platform to reduce mineral and biological fouling
- ▶ Includes a high purity self-cleaning and purge cycle to extend filter life without salt or chemical pre-treatment

Manufacturing Options & Sizing

SMARTGUARD SG-36K

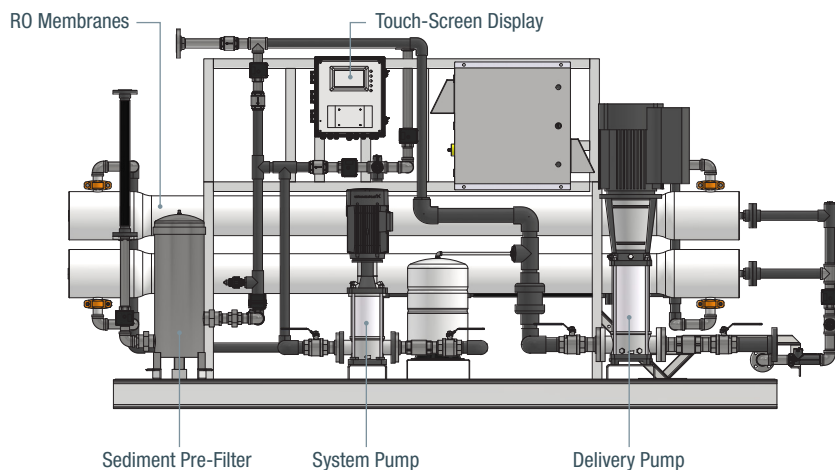

SMARTGUARD SG-1000

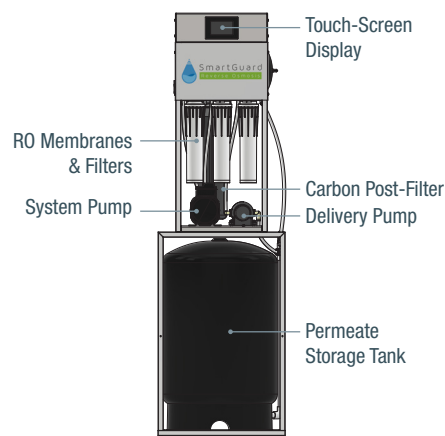

Model # ¹	Nominal GPD Sizing ²	Permeate GPM Max ³	Membrane Sizes & Array
SG-500	500	.3	3 - 3" x 10"
SG-1000	1,000	.6	3 - 3" x 15"
SG-2000	2,000	1.25	1 - 4" x 40"
SG-4000	4,000	2.5	2 - 4" x 40"
SG-6000	6,000	3.75	3 - 4" x 40"
SG-8000	8,000	5	4 - 4" x 40"
SG-12K	12,000	7.5	6 - 4" x 40"
SG-18K	18,000	11	3 - 8" x 40"
SG-24K	24,000	15	4 - 8" x 40"
SG-36K	36,000	22	6 - 8" x 40"
SG-48K	48,000	30	8 - 8" x 40"
SG-72K	72,000	45	12 - 8" x 40"
SG-96K	96,000	60	16 - 8" x 40"
SG-144K	144,000	90	24 - 8" x 40"
SG-192K	192,000	120	32 - 8" x 40"
SG-240K	240,000	150	40 - 8" x 40"
SG-288K	288,000	180	48 - 8" x 40"
SG-336K	336,000	210	56 - 8" x 40"
SG-384K	384,000	240	64 - 8" x 40"
SG-432K	432,000	270	72 - 8" x 40"
SG-864K	864,000	540	144 - 8" x 40"

Compact sizes, storage tanks, delivery pumps, DI filtration, UV sanitization and .2 micron post filtration are among the many options available with SmartGuard RO. Contact EasyWater or local rep for more info.

¹ To select an RO Model #, first determine the maximum gallons per day (GPD) needed and the maximum gallons per hour (GPH) needed during peak usage. Next, determine the maximum flow rate (GPM) that needs to be delivered to the point of use. These design parameters are used to select the RO system Model #, storage tank capacity and delivery pump size to meet these GPD, GPH, and GPM demands.

² As a general rule, the actual volume needed per day should not exceed 50% of the nominal rating. "Nominal GPD Sizing" is not a practical design parameter and is based on 24/7 operation with ideal pressure, temperature, TDS and filter condition.

³ "Permeate GPM Max" gives a realistic expectation of the peak performance in actual operating conditions.



SEDIMENT SHIELD®

SUB-MICRON FILTRATION SYSTEM

Industry leading sub-micron filtration for sediment, bacteria and other organics

FEATURES & BENEFITS

- ▶ Proprietary blend of media filters to less than 1 micron
- ▶ Backwashes clean and does not harbor bacteria
- ▶ SedimentShield media has an expected life of 20+ years
- ▶ Removes approximately 99% of bacteria in water

TYPICAL APPLICATIONS

- ▶ Well Water Filtration
- ▶ Domestic Water Filtration
- ▶ Process Water Filtration
- ▶ Sidestream Cooling Tower Filtration
- ▶ Sidestream Closed Loop Filtration

How SedimentShield Compares to Other Filtration Systems

	EasyWater SedimentShield®	Sand Filters	Centrifugal Separators	Disc Filters
Micron Filtration Level	Less than 1	40	75	50
Media / Equipment Life	20+ years	3 years	15+ years	15+ years
Backwashes Clean	Yes	No	Yes	Yes
Doesn't Harbor Bacteria	Yes	No	Yes	Yes
Bacteria Removal*	Excellent (Approx. 99%)	Minimal	Very Minimal	Very Minimal

*Bacteria ranges between .3 and 60 microns in size.

Manufacturing Options & Sizing

SKID-MOUNTED WITH PUMP

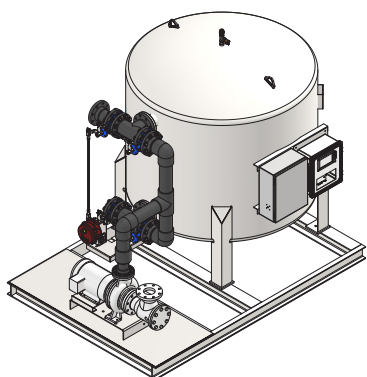

Model #	Steel Tank Dim	Sidestream GPM
SS-12-S	12" x 60"	12
SS-25-S	18" x 60"	25
SS-50-S	24" x 60"	50
SS-75-S	30" x 65"	75
SS-100-S	36" x 65"	100
SS-150-S	42" x 65"	150
SS-185-S	48" x 72"	185
SS-235-S	54" x 72"	235
SS-300-S	60" x 72"	300
SS-360-S	66" x 72"	360
SS-425-S	72" x 72"	425
SS-500-S	78" x 72"	500
SS-580-S	84" x 72"	580

Model selection can vary based on water quality and system volume.

Options such as stainless tanks, piping and skids along with dual pumps and various control options are available upon request. Contact EasyWater or local rep for more information.

INDIVIDUAL COMPONENTS WITH PUMP

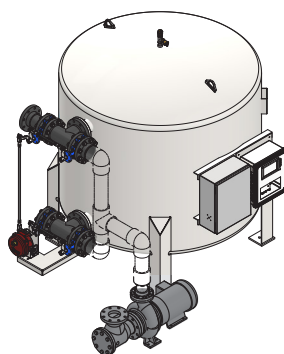

Model #	Filtration Tanks	Sidestream GPM
SS-12-P	12" x 54" FRP	12
SS-20-P	16" x 65" FRP	20
SS-35-P	21" x 62" FRP	35
SS-50-P	24" x 72" FRP	50
SS-75-P	30" x 72" FRP	75
SS-75-P	30" x 65" Steel	75
SS-100-P	36" x 72" FRP	100
SS-100-P	36" x 65" Steel	100
SS-150-P	42" x 72" FRP	150
SS-150-P	42" x 65" Steel	150
SS-185-P	48" x 72" Steel	185
SS-200-P	2 - 36" x 72" FRP	200
SS-235-P	54" x 72" Steel	235
SS-300-P	60" x 72" Steel	300
SS-300-P	2 - 42" x 72" FRP	300
SS-360-P	66" x 72" Steel	360
SS-425-P	72" x 72" Steel	425
SS-450-P	3 - 42" x 72" FRP	450
SS-500-P	78" x 72" Steel	500
SS-580-P	84" x 72" Steel	580
SS-600-P	4 - 42" x 72" FRP	600

Model selection can vary based on water quality and system volume.

Options such as stainless tanks along with dual pumps and various control options are available upon request. Contact EasyWater or local rep for more information.

INDIVIDUAL COMPONENTS WITHOUT PUMP

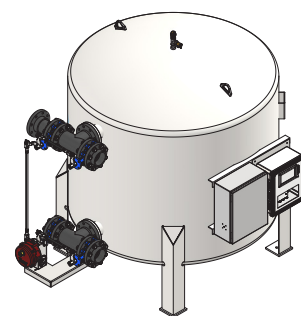

Model #	Filtration Tanks	Max Treatment GPM
SS-12	12" x 54" FRP	12
SS-20	16" x 65" FRP	20
SS-35	21" x 62" FRP	35
SS-50	24" x 72" FRP	50
SS-75	30" x 72" FRP	75
SS-75	30" x 65" Steel	75
SS-100	36" x 72" FRP	100
SS-100	36" x 65" Steel	100
SS-150	42" x 72" FRP	150
SS-150	42" x 65" Steel	150
SS-185	48" x 72" Steel	185
SS-200	2 - 36" x 72" FRP	200
SS-235	54" x 72" Steel	235
SS-300	60" x 72" Steel	300
SS-300	2 - 42" x 72" FRP	300
SS-360	66" x 72" Steel	360
SS-425	72" x 72" Steel	425
SS-450	3 - 42" x 72" FRP	450
SS-500	78" x 72" Steel	500
SS-580	84" x 72" Steel	580
SS-600	4 - 42" x 72" FRP	600

Model selection can vary based on water quality.

Options such as stainless and steel tanks are available upon request. Contact EasyWater or local rep for more information.

No-SALT CONDITIONER™



Prevent and remove hard water scale deposits and bio-film without salt or chemicals

Why Does Scale Form Inside Water-Using Equipment?

- 1 Change in Temperature
- 2 Change in Pressure
- 3 Turbulence

How the No-Salt Conditioner Prevents and Removes Scale:

UNTREATED MINERALS

- ▶ As water sees a change in temperature, pressure or turbulence, some of the minerals fall out of solution and are floating or suspended in the water
- ▶ The untreated minerals look like tree branches and have an electrostatic charge (like static electricity) on their surface, causing them to stick to the inside of water-using equipment and form scale deposits

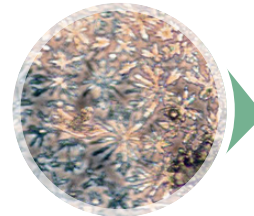

Microscopic view of **UNTREATED** hard water with sticky tree branch-like shape

TREATED MINERALS

- ▶ No-Salt Conditioner treatment causes the tree branch shaped minerals to cling to each other and form disc-shaped minerals, and as a result, they lose the electrostatic charge and their ability to stick
- ▶ When the tree branch-shaped minerals cling to each other and form these discs, it creates more capacity or “room” in the water to dissolve mineral and slowly remove existing scale deposits

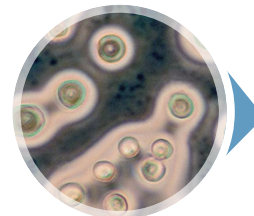

Microscopic view of **TREATED** hard water with disc-like shape

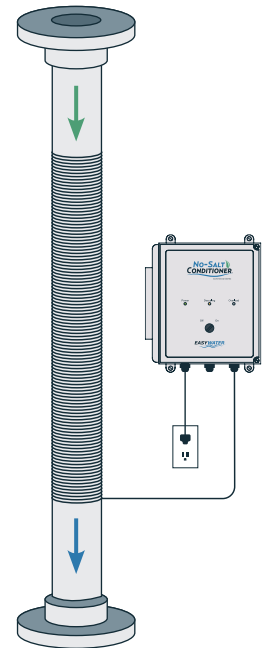

“ This test clearly proves the EasyWater No-Salt Conditioner lives up to its claims in a real-world situation. ”

— Bryan Schoening, Facility Maintenance Director for Core Civic / Nevada Southern Detention Center

Aerator After 6 Months of Treatment



See next page or our website for more photos and details about this test

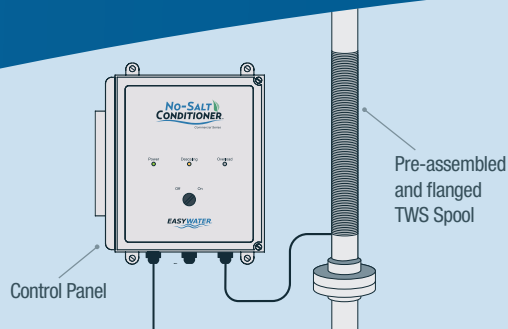

INSTALLATION

- ▶ No-Salt Conditioners are installed on all domestic cold water mains and all hot water recirculating loops

FEATURES & BENEFITS

- ▶ Pre-assembled and flanged treatment wraps (TWS Spools) supplied for installation
- ▶ Sturdy, NEMA 4X controller housing
- ▶ Heat-dissipating aluminum fins
- ▶ Ability to service two pipes
- ▶ No service or maintenance costs
- ▶ Estimated life of 10 to 15 or more years
- ▶ Dry Contacts for Remote Monitoring Available

EQUIPMENT PROTECTION EXAMPLES

- ▶ Domestic water heaters / Heat exchangers
- ▶ Mixing valves
- ▶ Piping
- ▶ Pumps
- ▶ Showerheads
- ▶ Aerators
- ▶ Flush valves

TYPICAL APPLICATIONS

- ▶ Domestic hot and cold water
- ▶ Process water
- ▶ Well/lake water used for condensing or cooling
- ▶ Heating water using waste heat

No-Salt Conditioner Case Studies

Iowa State University

6-Month Domestic Water Steam Heat Exchanger Test Results



BEFORE: 6 Months without EasyWater Treatment

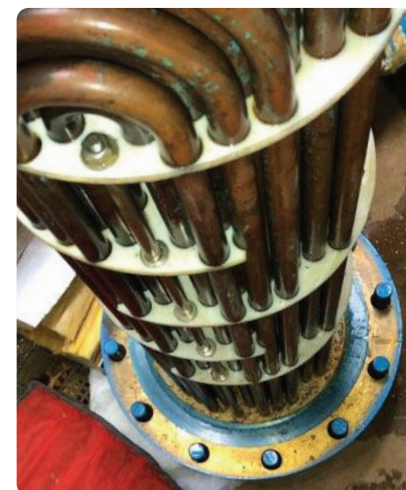

AFTER: 6 Months with EasyWater Treatment

Core Civic: Nevada Southern Detention Center

Domestic Water Heater Test Results



BEFORE: 4 Months — Water Heater without EasyWater Treatment



AFTER: 4 Months — Water Heater with EasyWater Treatment

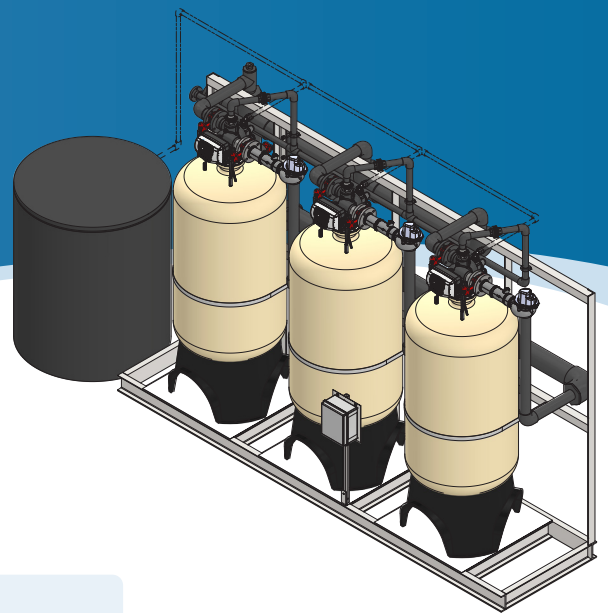

An efficient, long lasting water softener designed for your facility

SimplySoft by EasyWater combines superior design and the highest quality components to deliver a low-maintenance softener that is simple to use and easy to maintain. SimplySoft provides you with soft water while reducing the damaging lime scale deposits and spotting caused by hard water. Plus, the smart metered control valve reduces water and salt usage and our long lasting resin resists breakdown to give you years of reliable performance.

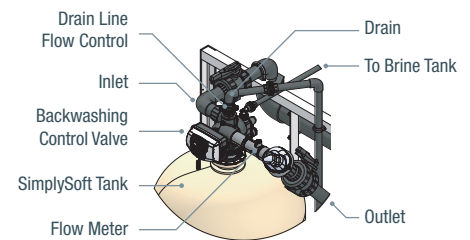

FEATURES & BENEFITS

- ▶ Smart-metered control valve
- ▶ Easy to service / Maintenance friendly
- ▶ Strong, long-lasting, chlorine-resistant resin
- ▶ Compatible with sodium chloride or potassium chloride
- ▶ Automatically adjusts and adapts to usage fluctuations based on rolling history
- ▶ Superior resin for increased life span of equipment
- ▶ Reduced maintenance costs associated with scale and hard water
- ▶ Saves water by regenerating on usage and not time
- ▶ Efficient salt usage based on no unneeded regenerations

OPTIONS

- ▶ Complete pre-engineered systems with 3/4", 1", 1-1/2", 2" & 3" valves
- ▶ Custom tailored systems through 6" valves
- ▶ Single and multi-tank systems
- ▶ Progressive flow and twin alternating
- ▶ Fiberglass, Steel and stainless tanks
- ▶ Metal and non-metal valve and piped systems
- ▶ Data output and building automation capable

TYPICAL APPLICATIONS

- ▶ Domestic water
- ▶ Commercial dishmachines
- ▶ Commercial laundries
- ▶ Cooling tower makeup
- ▶ Steam boilers
- ▶ Process water
- ▶ Car washes



POOL SHIELD™

POOL & SPA TREATMENT SYSTEM

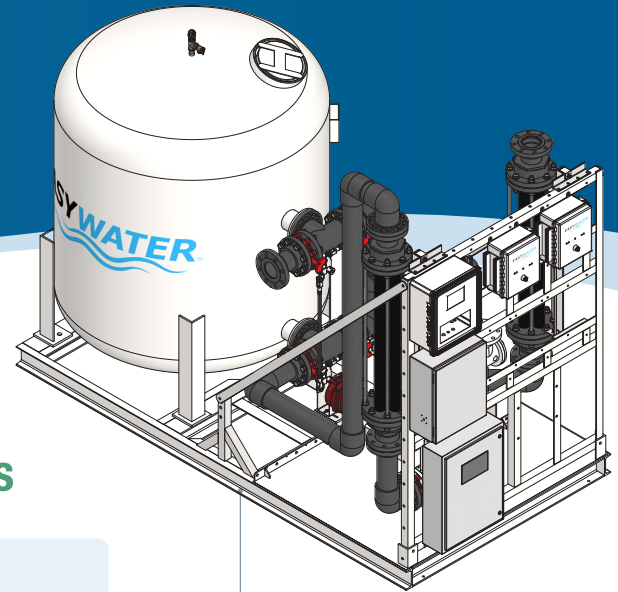

Skid-Mounted PoolShield System

Also see individual components option on next page

An innovative way to significantly reduce the use of chemicals while providing better results

The 4 Major Problems in Pools, Spas & Bodies of Water:

- 1 Harsh chemicals irritating skin and eyes
- 2 Disinfection By-Products (DBPs) created as chemicals kill bacteria
- 3 Risk of Legionella, Cryptosporidium and Pseudomonas
- 4 Scale and Biofilm forming on pool walls and in pool equipment

How PoolShield Solves the 4 Major Problems in Pools, Spas & Bodies of Water:

SEDIMENTSHIELD SUB-MICRON FILTRATION

- ▶ Utilizes EasyWater's proprietary blend of filtration media that backwashes clean and does not harbor bacteria
- ▶ Removes over 99% of bacteria in the water, dramatically reducing the amount of chlorine and other harsh pool chemicals
- ▶ Minimizing chlorine greatly enhances the swimming experience (eye/skin irritation)
- ▶ For indoor pools, significant reduction in chlorine minimizes damage/corrosion to building materials like steel, aluminum and wood
- ▶ Sub-micron filtration results in cleaner, clearer water and extremely low bacteria counts
- ▶ SedimentShield media has an expected life of 20+ years, unlike sand which requires replacement every 3 years
- ▶ Significantly reduces turbidity or cloudiness in the water, which increases the effectiveness of the UV system

ULTRAVIOLET (UV) SYSTEM

- ▶ Kills bacteria, including Cryptosporidium, on contact
- ▶ Reduces chlorine and other chemicals, which saves money and simplifies the water treatment process
- ▶ UV provides highly effective sanitization and is protected from deposits and performance loss by the SedimentShield filtration and No-Salt Conditioner

NO-SALT CONDITIONERS

- ▶ Eliminates scale and biofilm on the pool surfaces, and in the pool heater, piping and other equipment
- ▶ Removes scale and biofilm in the UV, which helps maintain its rated effectiveness
- ▶ Minimizes system scale and biofilm where the Legionella and Pseudomonas hide and multiply, reducing the risk of disease
- ▶ Breaks down the cell wall of bacteria
- ▶ Causes flocculation of particles in the water, increasing filtration effectiveness
- ▶ Removes insulating limescale from pool/spa heater, which saves energy and lengthens the life of the heater



“ Though chlorine can kill Cryptosporidium, both Pseudomonas and Legionella can survive disinfectants in slimy areas (called biofilm) of hot tubs, pools, and water playgrounds, the CDC said. ”

— Hotel pools a factor in water-related illness outbreaks, Stephanie Soucheray | News Reporter | CIDRAP News | May 17
<https://www.cidrap.umn.edu/news-perspective/2018/05/hotel-pools-factor-water-related-illness-outbreaks>

PROBLEM WATER SOLUTIONS



Instead of using salt or chemicals, EasyWater's IronShield uses natural air and a proprietary filtration media to eliminate undesirable staining, odors and suspended solids within one filtration tank.

ENGINEERED FILTRATION MEDIA

- ▶ Removes up to 20ppm of combined iron, manganese, H₂S, and tannins at pH as low as 5.8
- ▶ Filtration of sediment, dirt particles and sand down to 3 microns
- ▶ Light weight media requires less backwash time and flow thereby using less water during regeneration
- ▶ Natural media uses no chemicals and produces no disinfection byproducts

LOW MAINTENANCE

- ▶ No salt or chemicals to add, no filter cartridges to change
- ▶ Long-life filtration media lasts up to 10 years

ENVIRONMENTALLY FRIENDLY

- ▶ No harmful contaminants are added to the environment
- ▶ Uses only air and water to regenerate, instead of chemicals or salt
- ▶ Proprietary filtration media blend is all-natural and long-lasting



EasyWater's ToxinShield uses our natural proprietary filtration media to remove chlorine & chloramines, disinfection byproducts (DBPs), and many other contaminants in water.

ENGINEERED FILTRATION MEDIA

- ▶ ToxinShield uses a blend of different types of carbon media to remove various toxins in water
- ▶ The blend of carbon varies, depending on what toxins are present
- ▶ ToxinShield Removes / Reduces:
 - Chlorine and Chloramines
 - Disinfection Byproducts
 - Volatile Organic Compounds (VOCs)
 - Pesticide and Herbicides
 - Trihalomethanes (THMs)
 - Petroleum Products

OPTIONS

- ▶ Complete pre-engineered systems with 3/4", 1", 1-1/4", 1-1/2", 2" & 3" valves
- ▶ Custom tailored systems through 6" valves
- ▶ Single, twin-alternating and multi-tank systems
- ▶ Fiberglass, steel and stainless tanks
- ▶ Metal and non-metal valve and piped systems
- ▶ Data output and building automation capable

TYPICAL APPLICATIONS

- ▶ Domestic water
- ▶ Process water

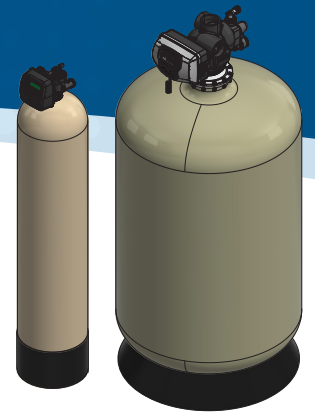

EasyWater's LeadShield uses our natural proprietary filtration media to remove lead, arsenic and many other heavy metals in water.

FEATURES & BENEFITS

- ▶ Disposable filter media for removal of lead, arsenic, and other heavy metals
- ▶ Removes over 98% of lead*
- ▶ Uses no chemicals or salt
- ▶ Effective removal over a wide pH range
- ▶ Removes both forms of Arsenic - AS(III) and AS(V)
- ▶ Continues to perform in the presence of silica, phosphate and sulfate
- ▶ Efficient filtration media uses less water for backwash
- ▶ Programmable control valve automatically regenerates filter media
- ▶ 10 year warranty on tank
- ▶ 5 year warranty on valve and electronics
- ▶ All NSF or WQA approved components
- ▶ Min/max pressure: 20-125 psi / Min/max temp: 40-110° F

*Under most conditions when properly operated and maintained. Test water regularly to confirm removal.

REMOVES OR REDUCES

- ▶ Lead
- ▶ Arsenic
- ▶ Fluoride
- ▶ Sediment
- ▶ Radioactive Particles
- ▶ Zinc
- ▶ Copper
- ▶ Uranium
- ▶ Radium
- ▶ Aluminum
- ▶ Arsenic III
- ▶ Arsenic IV
- ▶ Mercury
- ▶ Chromium III
- ▶ Chromium VI
- ▶ Nickle
- ▶ Silver
- ▶ Cadmium

How EasyWater's Problem Water Solutions Work:

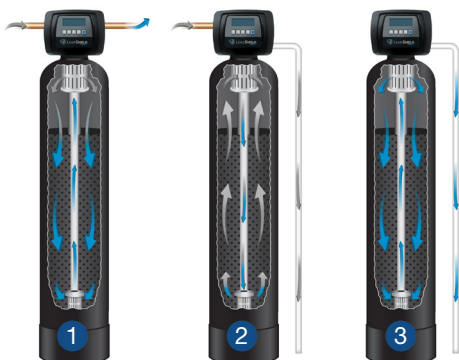

- 1) In-Service:** Untreated water enters the filter, and contaminants are trapped in the natural media
- 2) Backwash:** Upward flow of water lifts the filter bed, removing trapped contaminants and increasing the life of the media
- 3) Fast Rinse:** Filter bed is packed down to prepare for the next filtration cycle



EASYWATER[®]

CALL (888) 766-7258
easywater.com/commercial